



Kommunikációs rendszerekben gondolkodunk



Patton SmartNode termékek a Young kínálatában

Kreszta Zoltán - termékmanager

2014. május 8.

Miről lesz szó?



1.

Néhány szó a Pattonról

2.

Patton SmartNode
termékcsalád
bemutatása

3.

Alkalmazási példák a
gyakorlatban

Patton Electronics

- 30 éves, 1984-ben alapított vállalat (USA)
- Családi tulajdon (Bobby és Burt Patton)
- Modemek összeszerelésével kezdték
- Két év után az apuka, Robert nyugdíjpénztári megtakarításából indult a növekedés
- 2002-2003 - Európai terjeszkedés kezdete a svájci Inalp Networks beolvasztásával
- Alkalmazottak száma: 180 („mikro-multinacionális” cég)
- Éves átlagban 22%-os forgalombővülés



Patton SmartNode termékek

Közben...



JÖVŐ
Full IP

MÚLT
Analóg, ISDN
(TDM)

Patton SmartNode termékek előnyei

- „Made in the USA”
- Szoftver-fejlesztés, VoIP-kompetencia központ Svájcban
- Ingyenes alap-support és szoftver-upgrade
- Egységes szoftver-platform (SmartWare)
- Ingyen update kéthavonta
- Ingyen upgrade félévente
- 7x24 Premium Support
- Budapesti régiós központ (Kelet-közép Európa)

Patton fejlesztő partnerek

AVAYA



winet
network solutions

3CX



snom
VoIP phones



Patton softphone partnerek



Patton VoIP-szolgáltató partnerek Magyarországon



Patton SmartNode termékek szolgáltatásai

- IP-TDM integráció
- Analóg FXS/FXO, digitális ISDN BRI és PRI interfészek:
 - 1-32 FXS/FXO
 - 1-8 ISDN BRI
 - 1-64 ISDN PRI
- 1-től 2016 egyidejű VoIP vagy faxhívás kapacitás
- VoIP-gateway, IP-router, transcoding
- SIP, H.323, ISDN, T.38-fax egyidejű támogatása

Patton SmartNode áttekintés







	Gateway	Gateway-Router	Integrated Access Device (IAD)	Enterprise Session Border Router (ESBR)
VoIP Gateway	✓	✓	✓	
IP Router IP Routing, QoS, VPN, stb.		✓	✓	✓
WAN Access: Fiber, G.SHDSL, ADSL, X.21, V.35			✓	Optional
Transcoding: Interconnects multiple VoIP networks		Opcionális	Opcionális	Opcionális











Patton SmartNode analóg termékek

	M-ATA	SN4110	SN4520	SN4830	SN4300	SN4400	SN4900*
SmartWare™							
Telefonos interfész	FXS	FXS & FXO	FXS & FXO	FXS & FXO	FXS or FXO	FXS or FXO	FXS or FXO
Telefonos portok száma	1	2, 4, 6, 8	2, 4, 6, 8	2, 4, 6, 8	12, 16, 24, 32	12, 16, 24, 32	12, 16, 24, 32
VoIP Gateway							
IP Router IP Routing, QoS, VPN, stb.							
Ethernet portok száma	1	1	2	2	1	2	2
WAN Access				ADSL G.SHDSL Serial X.21 Serial V.35			(Opcionális) Serial X.21 Serial V.35











Patton SmartNode ISDN termékek

	SN-DTA	SN4120	SN4630	SN4650	SN4660	SN4670
SmartWare™						
Telefonos interfész	BRI (NT vagy NT+TE)	BRI (TE)	BRI	BRI	BRI with FXS/FXO	BRI with FXS/FXO
Telefonos portok száma	1 vagy 2	1 vagy 2	3 vagy 5	3 vagy 5	Max. 12	Max. 12
VoIP hívások száma	2 vagy 4	2 vagy 4	4 vagy 8	4 vagy 8	Max. 24	Max. 24
VoIP Gateway	✓	✓	✓	✓	✓	✓
IP Router IP Routing, QoS, VPN, stb.			✓	✓	✓	✓
Ethernet portok száma	1	1	2	1	4	4
WAN Access				ADSL G.SHDSL Serial X.21 Serial V.35		Fiber ADSL G.SHDSL, EFM

Patton SmartNode PRI termékek

	SN4970  IPv6	SN4980  IPv6	SN4990  IPv6
SmartWare™			
Telefonos interfész	T1/E1/PRI	T1/E1/PRI	T1/E1/PRI
Telefonos portok száma	1 vagy 4	1 vagy 4	1 vagy 4
VoIP hívások száma	15, 24, 30, 48, 60, 96, 120	15, 24, 30, 48, 60, 96, 120	15, 24, 30, 48, 60, 96, 120
VoIP Gateway			
IP Router IP Routing, QoS, VPN, stb.			
Ethernet portok száma	1	2	2
Transcoding: Interconnect multiple VoIP networks		Opcionális	Opcionális
WAN Access			Fiber G.SHDSL, EFM, Serial X.21
Előző típus	SN4940	SN4950	SN4950/SN4960

Patton SmartNode Enterprise Session Border Router (ESBR) termékek

	SN5200	SN5480 	SN5490 
SmartWare™			
SIP Sessions a back-to-back call using two SIP legs	Max. 32	Max. 196	Max. 196
Transcoded Calls 1 Transcoded Call = 2 Voice Channels	N/A	Max. 64	Max. 64
Ethernet portok száma	5	2	2
IP Router IP Routing, QoS, VPN, stb.			
Transcoding: Interconnects multiple VoIP networks			
WAN Access	X.21		Fiber G.SHDSL, EFM, X.21

Patton SmartNode alkalmazási példák 1.

Távoli analóg mellékek kiadása

Fő iroda

Távoli telephely

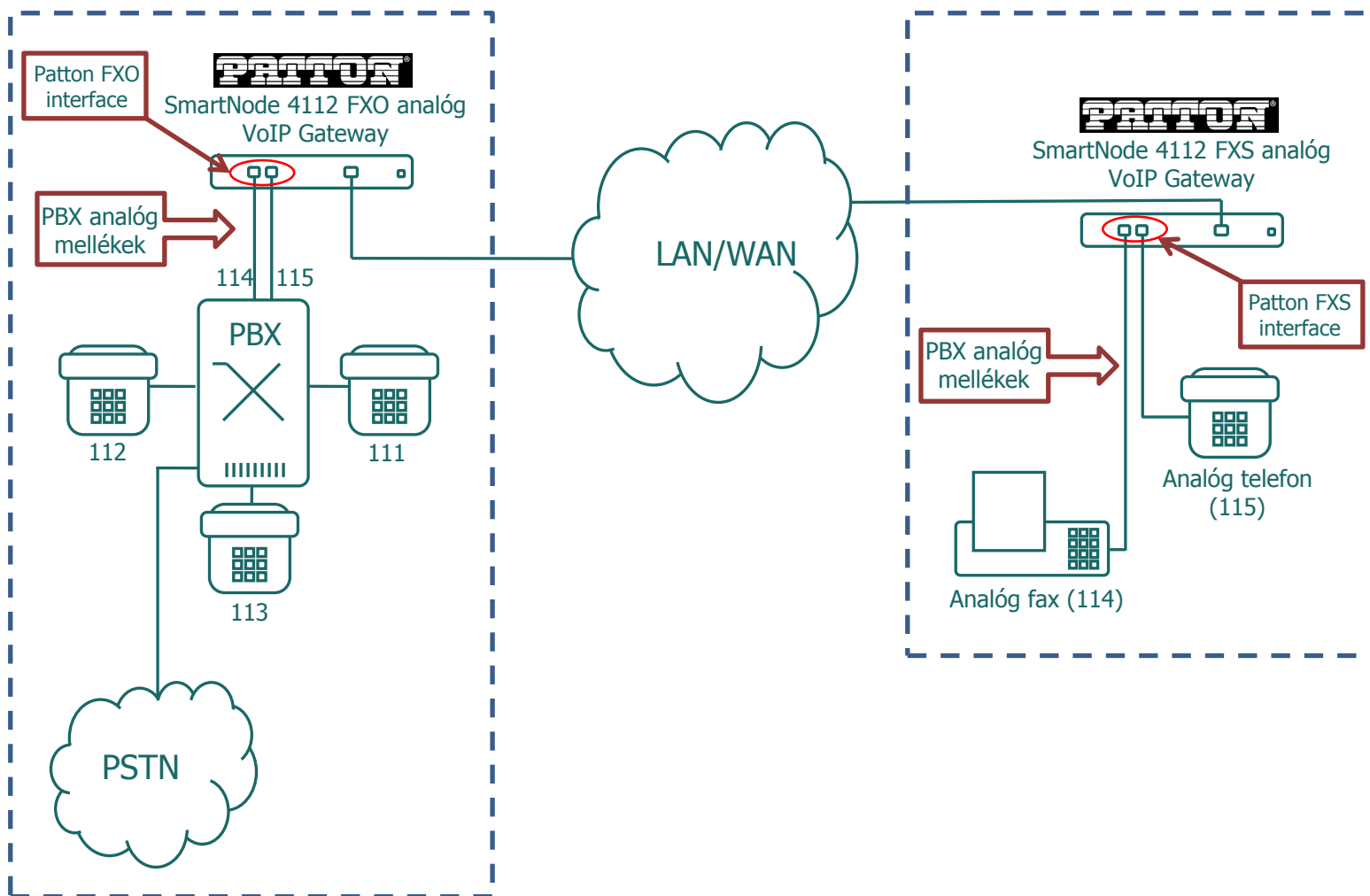

Patton SmartNode alkalmazási példák 2.

Távoli analóg mellékek kiadása több telephelyre

Fő iroda

Távoli telephely 1.

Távoli telephely 2.

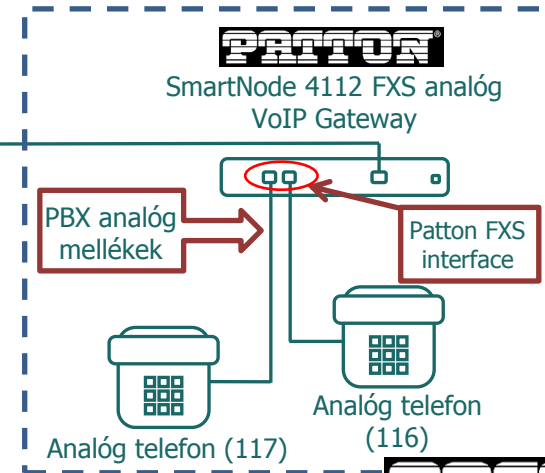
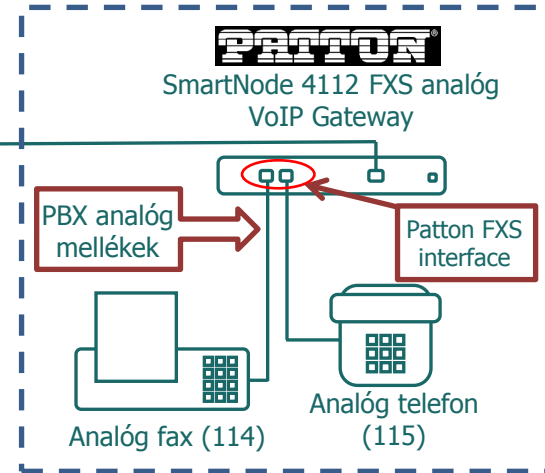
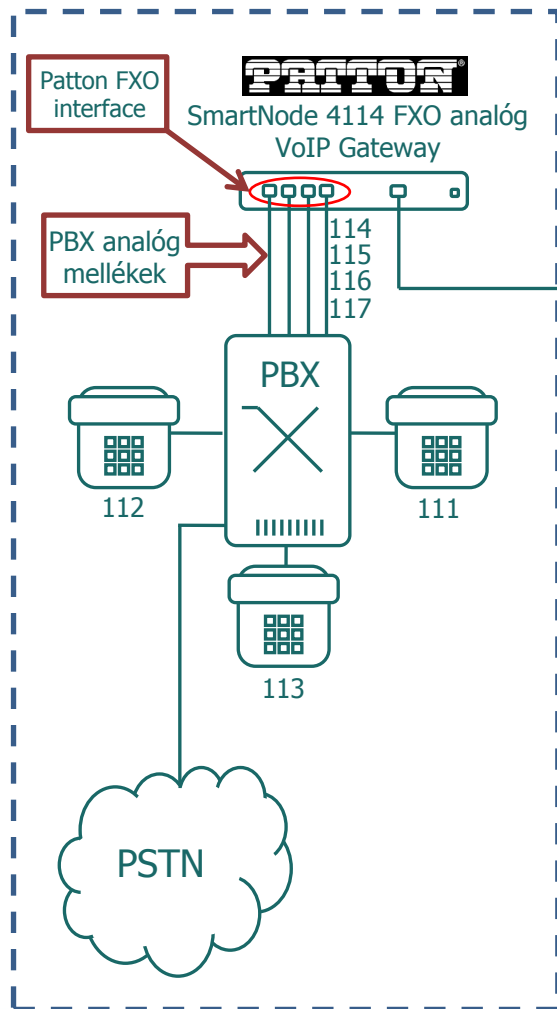

Patton SmartNode alkalmazási példák 3.

Analóg mellékek kiadása IP-s alközpontból

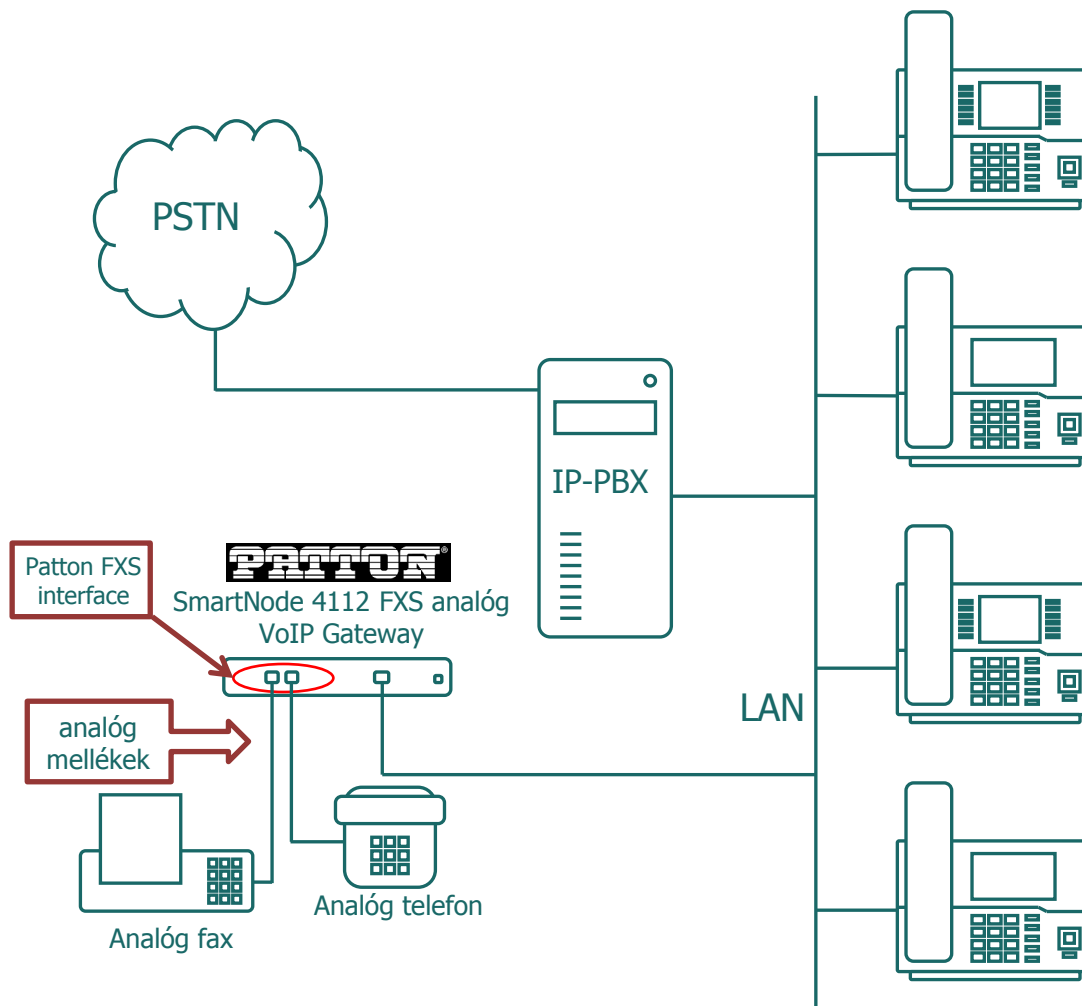



Köszönöm a figyelmet!

Kreszta Zoltán

értékesítési menedzser - Ascom

Young B.T.S. Kft.

H-1139 Budapest, Frangepán u. 26.

Telefon: +36 (1) 452-2649

Telefax: +36 (1) 452-2650

Mobil: +36 (30) 819-2649

E-mail: kreszta.zoltan@young.hu

Web: <http://www.young.hu/>



K O M M U N I K Á C I Ó S R E N D S Z E R E K B E N G O N D O L K O D U N K